

E13-2008-110

J. Budagov¹, A. Chernikov¹, B. Sabirov¹, A. Sissakian¹, G. Shirkov¹,
A. Sukhanova¹, I. Malkov², V. Perevozchikov², V. Rybakov², V. Zhigalov²,
A. Basti³, F. Bedeschi³, F. Frasconi³, S. Linari³, R. Kephart⁴, S. Nagaitsev⁴

LEAK RATE MEASUREMENTS ON BIMETALLIC TRANSITION SAMPLES FOR ILC CRYOMODULES

¹Joint Institute for Nuclear Research, Dubna, Russia

²Russian Federal Nuclear Center — All-Russian Scientific Research Institute of Experimental Physics,
Sarov, Russia

³Istituto Nazionale di Fisica Nucleare, Sezione di Pisa, Italy

⁴Fermi National Accelerator Laboratory, Batavia, USA

Будагов Ю. и др.

E13-2008-110

Измерение уровня течи биметаллических переходных образцов для криомодуля международного линейного коллайдера

Приводятся результаты тестов на герметичность биметаллических (титан – нержавеющая сталь) переходных элементов, изготовленных методом сварки взрывом. Вакуумные испытания и испытания под давлением на герметичность образца проводились при температуре окружающей среды и в жидком азоте. Аналогичные тесты были проведены после серии термоциклирования образца.

Работа выполнена в Лаборатории ядерных проблем им. В. П. Дзелепова ОИЯИ.

Сообщение Объединенного института ядерных исследований. Дубна, 2008

Budagov J. et al.

E13-2008-110

Leak Rate Measurements on Bimetallic Transition Samples for ILC Cryomodules

The results of leak test of bimetallic (titanium–stainless steel) transition elements produced by explosion welding are presented. Vacuum and high-pressure tests of the sample for leakage were carried out at room temperature and liquid nitrogen temperature. Similar tests were also carried out under thermal cycling conditions.

The investigation has been performed at the Dzhelepov Laboratory of Nuclear Problems, JINR.

Communication of the Joint Institute for Nuclear Research. Dubna, 2008

INTRODUCTION

In the current design the ILC cryomodules contain a large amount of structures made of titanium, which are both difficult to manufacture and expensive. In this note we have explored technique to significantly reduce the amount of titanium used by means of suitable titanium–stainless steel transitions made with explosion bonding by a Russian company in Sarov, and discuss the results obtained from tests on samples recently received.

In particular, in this note we report on the tests performed by a joint RFNC (Sarov), INFN (Pisa), and JINR (Dubna) team on a titanium–stainless steel (Ti–SS) transition sample manufactured in Sarov. These consist of metallographic analyses, leak checks under vacuum or high pressure both at room and liquid nitrogen temperatures. Such tests are repeated after extreme thermal cycling and have the goal to certify the explosion bonding technique for future application on ILC cryomodules.

The gas leak detectors used for the leak tests are the PFIFER-VACUUM HLT160 and the Wis Technologies MODUL200 equipped with a scroll pump (by VARIAN) to reach a preliminary vacuum level. A LabView based data acquisition system is used to read-out the temperature probes used in our tests.

1. METALLOGRAPHIC ANALYSES AND LEAK RATE MEASUREMENTS IN SAROV AND DUBNA

The welding method is based on the use of the explosion energy. The method is rather well known in the world, but it was used to weld flat pieces. In Sarov the method for welding tube pieces was developed. The following tasks were set:

- development of a tentative technical procedure for production of a bimetallic tube transition element by explosion welding;
- study of the microstructure of the welded joint;
- tests of the joint for leak at room and liquid nitrogen temperatures.

The first specimen of the bimetallic tube transition element was made in Sarov from the domestic materials, 12X18H10T Stainless Steel (SS) and VT1-0 Titanium (Ti) (see Fig. 1).

To carry out metallographic analysis, another specimen of the bimetallic transition was made and samples were cut out of it along the welded joint. The results of the metallographic analysis are as follows:

- 1) No macrodefects of welded joints are found.
- 2) The welded joint is of wave-like sinusoidal character, which contributes to an increase in the strength of the welded joint. The wave length and amplitude were 0.3 and 0.05 mm, respectively.
- 3) Individual microdefects are formed in explosion welding, but they are local and do not form a continuous layer.
- 4) Metal strengthening is observed in the welded joint area. The highest material strengthening occurs in a narrow area of ~ 0.5 mm wide near the titanium–steel interface; beyond this area strengthening decreases.
- 5) Measurement of the welded joint shear strength was carried out. An impressive result is obtained: $\zeta_{sh} \approx 250$ MPa.

A single test for leak was carried out: the measurement was performed with the PTI helium leak detector at room temperature before and after cooling in liquid nitrogen for 10 min. The measured value was $1 \cdot 10^{-9}$ atm·cm³/s. The specimen was demonstrated at the ILC Workshop in Milan in 2006, where it made a tremendous expression on the participants and enjoyed their general approval.

The next stage of our study was production of the bimetallic transition of materials to be used in the working version of the ILC cryomodule. The relevant materials, GRADE2 Ti (China) and 316L SS (Austria), were brought from INFN (Pisa, Italy). A transition tube with a coupling of Russian stainless steel was made by the explosion welding (see Fig. 1). This bimetallic sample was subjected to large-scale tests in Dubna and Pisa.

In Dubna the sample was put through six thermal cycling tests: cooling in liquid nitrogen (77 K) \rightarrow warming-up (300 K); cooling-down \rightarrow warming-up, and so on six times. Leak rate was

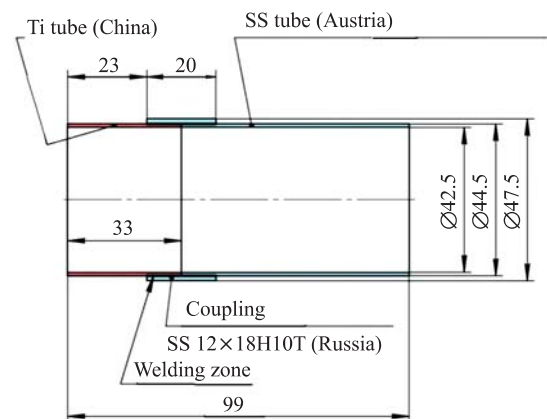

Fig. 1. The applied scheme for explosion welding process

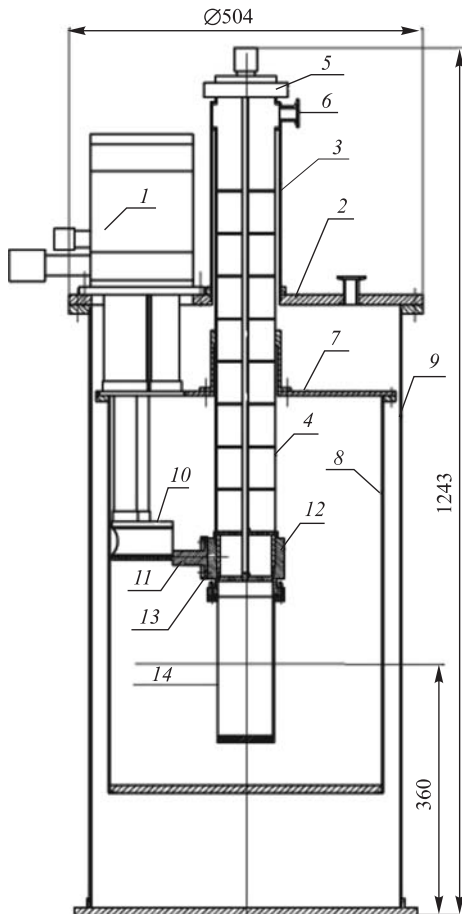

Fig 2. Shaft cryostat based on closed loop pulse tube refrigerator PT405 for the temperature range of 300–6 K. 1 — cold head PT405; 2 — flange of cryostat; 3 — head of cryostat; 4 — shaft; 5 — insert; 6 — flange NW25; 7 — flange cooled by first step of cold head; 8 — thermal shield; 9 — vessel of cryostat; 10 — second step of cold head; 11 — flexible thermal bridge; 12 — heat exchanger of insert; 13 — heater; 14 — sample chamber

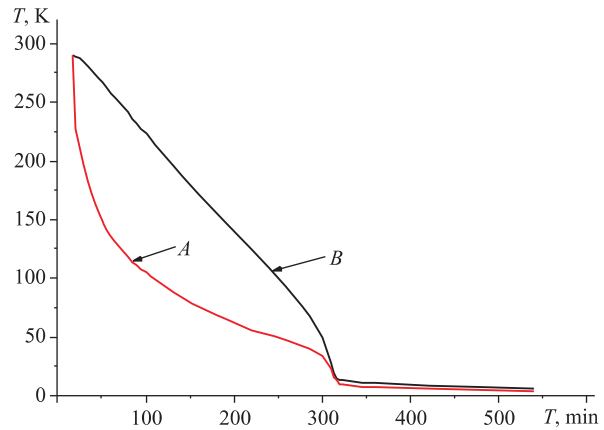

Fig. 3. Curves of the sample temperature (B) and second step of the cold head (A) at the cooling process

checked with the PFEIFER-VACUUM HLT160 leak detector at room temperature and the measured result was $Q \leq 10^{-7} \text{ l} \cdot \text{atm/s}$. Then the sample was filled with gaseous helium at pressure of 6.5 atm and the measured result was $Q \leq 10^{-7} \text{ l} \cdot \text{atm/s}$.

The next test was the test at the helium temperature: the sample was cooled down to $\sim 6 \text{ K}$ in the cryocooler and warmed up to room temperature. For helium temperature production we used shaft cryostat based on closed loop pulse tube refrigerator PT405 of Cryomech. Construction of the cryostat is presented in Fig. 2. The cryostat lets one to work with samples of 70 mm in diameter and 200 mm in length. Principal construction decisions and operate features of analogous cryostat were presented in [1].

Figure 3 presents curve of the sample temperature at the cooling process. About the same dependence would be expected in the following running conditions of investigated welded joint. Warming of the sample was produced by removal one from cryostat. After warming to 300 K (approximately within 1 h) the sample was inserted again to the sample chamber of the cryostat and cooled. Final temperature in the cooling process reached 6 K during 9 h. Six cycles like this were performed. The leak rate measurement at room temperature yielded the value $Q \leq 10^{-7} \text{ l} \cdot \text{atm/s}$.

2. LEAK TEST MEASUREMENTS ON THE Ti-SS TRANSITION SAMPLE IN PISA

The main goal of our measurements is to evaluate the quality of the junction obtained and its stability at cryogenic temperatures.

A dedicated set-up was made for these tests. It consisted of a blind stainless steel flange (DN63) to close the aperture on the titanium side and a stainless steel reduction (DN63–DN25) mounted to close the stainless steel aperture from the other side. Then a DN25 connection was mounted for the gas leak detector. The both o-rings on two flanges were hand-made by using the indium wire of 2 mm in diameter. The choice of this gasket was motivated by the need to carry out tests at two different temperatures: room and liquid nitrogen (300 and 77.3 K, respectively). The two standard stainless steel vacuum components (the blind flange DN63 and the DN63–DN25 reduction) and the joint sample were assembled together with 6 stainless steel threaded rods equipped with nuts and washers assuring the right vacuum seal (see Fig. 4, a).

The same gasket (indium wire) was applied for the connection between the flex pipe of the leak detector and the experimental set-up. The vacuum seal was completed by using a C-clamp (see Fig. 4, b).

2.1. Results of the Leak Tests at the Room and Liquid Nitrogen Temperatures. The bimetallic sample was wrapped with a plastic bag making a small volume where the gaseous helium was flown for several seconds (typically



Fig. 4. Experimental set-up of the Ti-SS transition sample: a) to be tested; b) connected to the leak detector with a C-clamp

3–5 s). In Fig. 5 the measurement set-up is visible during the ongoing test at the room temperature. The first measurement gave the following values:

T = 300 K

Vacuum level = $5.7 \cdot 10^{-3}$ mbar,

Leak rate background = $1.2 \cdot 10^{-10}$ mbar · l/s.

No changes were detected after filling the plastic bag with the gaseous helium.

After preliminary test the Ti-SS joint was connected to a flex pipe, tested at room temperature again and then immersed into a cryogenic Dewar filled with liquid nitrogen for about 30 min (elapsed time needed to have the system at thermal equilibrium with LN₂). The obtained results are shown below:

T = 83 K

Vacuum level = $5.7 \cdot 10^{-3}$ mbar,

Leak rate background = $6.0 \cdot 10^{-9}$ mbar · l/s (at 300 K),

Leak rate background = $3.4 \cdot 10^{-9}$ mbar · l/s (at 83 K).

No changes were detected after filling the plastic bag with the gaseous helium.

During the cryogenic test the temperatures were measured by two temperature diode sensors (model DT-630 produced by Lake Shore): the first one was attached to the sample to monitor the temperature inside the plastic bag; the second sensor was used to monitor the room temperature. In Fig. 6 the cool-down and warm-up temperature profiles of our sample are shown.



Fig. 5. The Ti-SS transition sample wrapped with a plastic bag for the leak test measurements

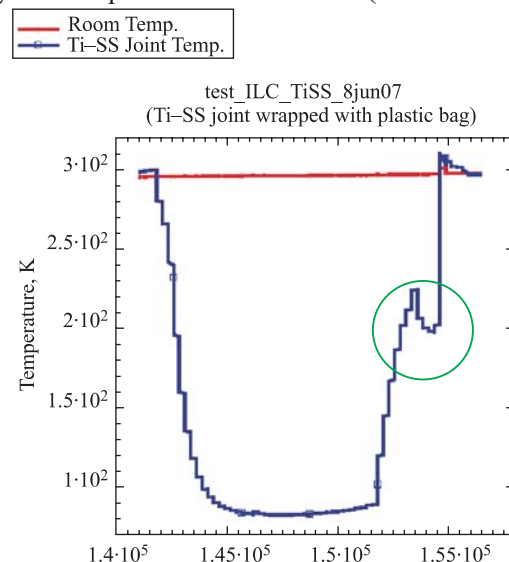

Fig. 6. The plot of the temperatures during the leak test measurement of the Ti-SS transition sample. The room temperature is given by the red curve while the blue one represents the sample temperature. On the right side of the plot a circle highlights the temperature of the second cold test

The second leak test was also performed at about 200 K (see circle in Fig. 6). The set-up was taken out from the Dewar and when the temperature reached almost 200 K the second leak test was carried out. No variation of the background level was observed:

T = 200 K

Vacuum level = $6.7 \cdot 10^{-3}$ mbar,

Leak rate background = $8.6 \cdot 10^{-9}$ mbar · l/s (at 200 K).

No changes were detected after filling the plastic bag with the gaseous helium.

2.2. Leak Tests after Thermal Cycling. A deeper investigation on the Ti–SS transition sample behaviour is of great importance for ILC applications considering that this part will be thermally stressed passing, in standard working conditions, from room temperature down to cryogenic temperatures. For these reasons we planned to thermally stress the sample making several thermal cycles starting from room temperature and cooling down it to liquid nitrogen temperature.

By using the same experimental set-up described above without a plastic bag, a set of leak rate and vacuum level measurements has been carried out during the thermal cycles of the bimetallic sample at 300 and 77 K. At the end of the cycles a measurement of the sample helium leak rate at room temperature has been repeated. In Fig. 7 different moments of the test are shown.

The cooling down procedure was very quick, it took a few minutes. The sample remained in contact with liquid nitrogen in the Dewar for about 15 min (the elapsed time necessary to have the system at thermal equilibrium with LN₂). The temperature of each thermal cycle was monitored by using two sensors: the first one attached to the sample (see the



Fig. 7. Different moments of the tests at the VIRGO cryogenic laboratory

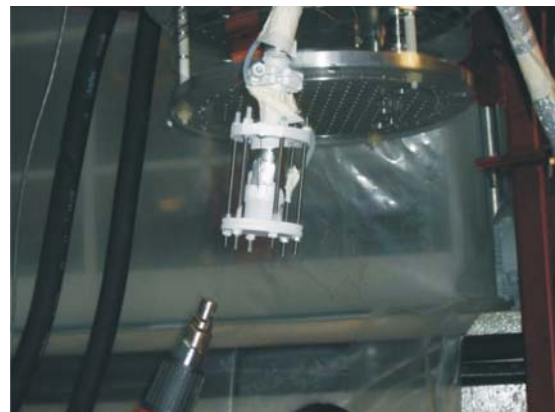

blue curve in Fig. 8) and the second one — monitoring the room temperature (see the red curve in Fig. 8). Then the sample was taken out from the Dewar and warmed up by means of a heat gun for fast heating and high thermal stress. The total number of thermal cycles performed in the range from the room to liquid nitrogen temperatures was seven, as shown in Fig. 8.

At each cycle we measured the values of the vacuum level and background leak rate both at room and liquid nitrogen temperatures. The results are summarized in Table 1.

It should be pointed out that between the fourth and fifth cycles the gas-ket (indium wire) between the leak de-

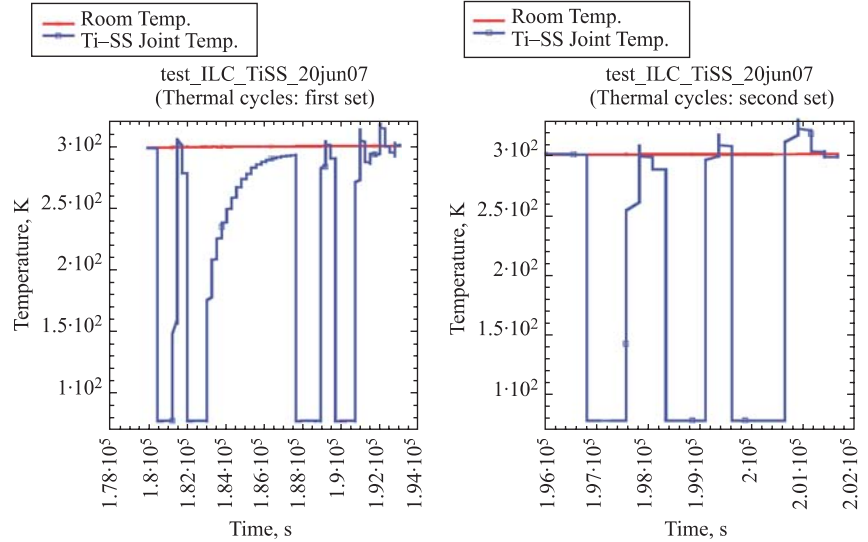

Fig. 8. Thermal cycling of the sample from the room to liquid nitrogen temperatures

Table 1. Total measurements of the set-up vacuum level in seven cycles

Number of the cycle	Vacuum level, mbar		Leak rate background, mbar · l/s	
	at 300 K	at 77.7 K	at 300 K	at 77.7 K
1	$6.7 \cdot 10^{-3}$	$6.0 \cdot 10^{-3}$	$2.4 \cdot 10^{-9}$	$2.3 \cdot 10^{-9}$
2	$6.7 \cdot 10^{-3}$	$6.0 \cdot 10^{-3}$	$1.4 \cdot 10^{-9}$	$1.3 \cdot 10^{-9}$
3	$6.7 \cdot 10^{-3}$	$6.3 \cdot 10^{-3}$	$9.0 \cdot 10^{-10}$	$4.2 \cdot 10^{-10}$
4	$6.7 \cdot 10^{-3}$	$9.0 \cdot 10^{-3}$	$1.7 \cdot 10^{-9}$	$2.5 \cdot 10^{-11}$
5	$7.3 \cdot 10^{-3}$	$6.7 \cdot 10^{-3}$	$7.1 \cdot 10^{-9}$	$6.9 \cdot 10^{-9}$
6	$7.0 \cdot 10^{-3}$	$6.7 \cdot 10^{-3}$	$5.0 \cdot 10^{-9}$	$4.5 \cdot 10^{-9}$
7	$6.7 \cdot 10^{-3}$	$6.3 \cdot 10^{-3}$	$3.6 \cdot 10^{-9}$	$3.3 \cdot 10^{-9}$

tector flex pipe and our sample was replaced due to vacuum tightness problem. At the end of these thermal cycles the sample was wrapped again with a plastic bag and filled by gaseous helium for the vacuum level and leak rate measurements obtaining the following results:

T = 300 K

Vacuum level = $7.0 \cdot 10^{-3}$ mbar,

Leak rate background = $3.1 \cdot 10^{-9}$ mbar · l/s.

No changes were detected after filling the plastic bag with the gaseous helium.

2.3. High Pressure Tests. Since the bimetallic transition sample could be used in the liquid helium distribution circuit of the ILC cyomodule, leak detection measurements of the sample were performed also at high pressure. For this reason our sample was connected to the helium bottle and filled with gaseous helium up to a pressure of about 6 bar (Fig. 9).



Fig. 9. The sample connected to the helium bottle and filled with gaseous helium up to a pressure of about 6 bar

Then the sample was carefully checked for the leaks by scanning the external explosion bonding joint with a probe connected to our leak detector. With this measurement technique it is possible to localize a leaking area, but the resolution on the real leak rate is considerably worse than the previous measurements. No leaks were found up to 10^{-7} mbar · l/s; this value is the best instrument sensitivity for this type of measurement.

3. THE Ti-SS TRANSITION SAMPLE WITH WELDED PLATES

In order to test the resistance of the bimetallic transition sample to TIG welding in its neighborhood we processed the sample previously tested as follows: a Ti plate was welded to close the Ti pipe and the stainless steel side of the joint was welded with a 3 mm thick stainless steel disk with a hole in the centre for welding a DN25 connection. The complete assembly is shown in Fig. 10.

The welding procedure was as follows: inside the welding box we used a container with ice and water to cool the Ti-SS sample during welding (Fig. 11). The water-ice level was close to the welding area. We carried out monitoring of the transition sample temperature by means of a probe connected to the external surface of the stainless steel collar. This temperature sensor is shown in Fig. 12. The welding procedure was very fast (about 5 min) and the registered temperature was always about +3 or +4 °C. The finished welded assembly is shown in Fig. 13.

We repeated on this welded part all the tests performed before with the simple Ti-SS transition sample using the same measurement technique:

- Leak check at the room temperature with a plastic bag filled with gaseous helium.
- Thermal cycles between 300 and 77.3 K and after the final (fifth) cycle new leak checks were performed at the room temperature.
- Leak tests were carried out under high pressure (about 6 bar of gaseous helium) inside the Ti-SS transition sample.

3.1. Results of the Leak Test at Room Temperature. The results of the tests at the room temperature are given below.

T = 300 K

Vacuum level = $6.7 \cdot 10^{-3}$ mbar,

Leak rate background = $3.4 \cdot 10^{-9}$ mbar · l/s.

No changes have been detected after filling the plastic bag with the gaseous helium for 3–5 s.

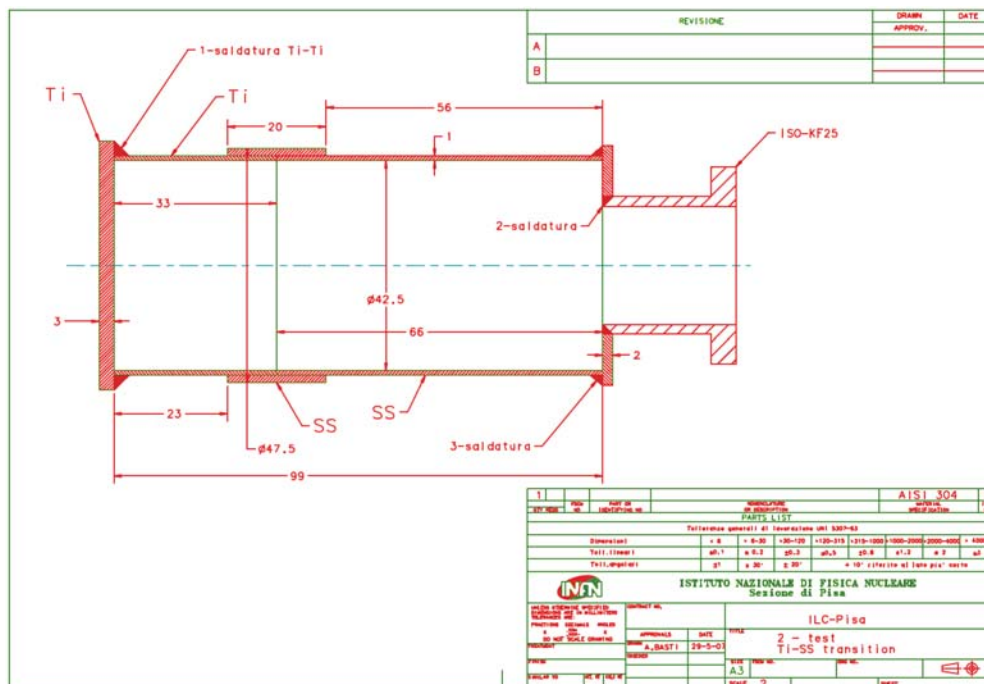

Fig. 10. Technical drawing of the Ti-SS joint with welded components



Fig. 11



Fig. 12



Fig. 13

3.2. Leak Test of the Sample after Thermal Cycling.

The procedure of this test has already been described in subsection 2.2. It was repeated with the Ti-SS transition sample having the welded components. Figures 14 and 15 show the measuring procedure.

The results obtained are given in Table 2 for 5 cycles at two different temperature levels. It should be noted that during the fourth cycle we did not record the vacuum level and background rate for our forgetfulness, but not relevant changes have been observed.



Fig. 14



Fig. 15

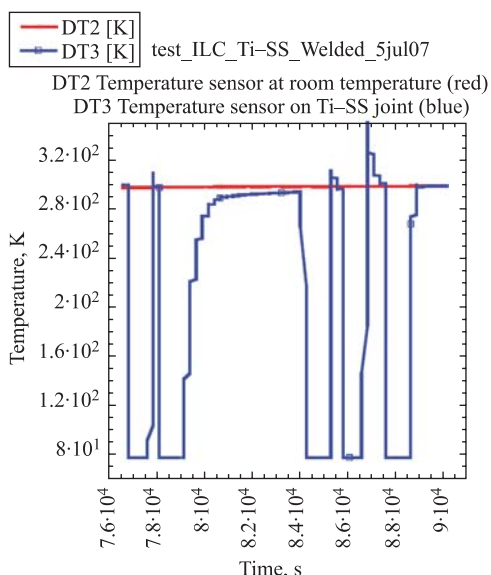

Fig. 16. The plot of the temperature during the leak test measurement of the Ti-SS sample. The room temperature is given by the red curve while the blue one represents the sample temperature

The plot in Fig. 16 illustrates the thermal cycling process.

After the last thermal cycle the sample was warmed up to room temperature with a heat gun and the vacuum level and leak rate background were measured. The results are shown below.

T = 300 K

Vacuum level = $6.3 \cdot 10^{-3}$ mbar,

Leak rate background = $3.5 \cdot 10^{-10}$ mbar · l/s.

After filling the bag with He gas we observed a significant leak. After careful study such a leak was traced to a problem with the SS-SS weld. Unfortunately, this prevented any further test on this sample.

Table 2. Total measurements of the set-up vacuum level in five cycles

Number of the cycle	Vacuum level, mbar		Leak rate background, mbar · l/s	
	at 300 K	at 77 K	at 300 K	at 77 K
1	$7.0 \cdot 10^{-3}$	$6.0 \cdot 10^{-3}$	$1.0 \cdot 10^{-3}$	$1.1 \cdot 10^{-9}$
2	$6.3 \cdot 10^{-3}$	$6.0 \cdot 10^{-3}$	$9.0 \cdot 10^{-10}$	$1.1 \cdot 10^{-9}$
3	$6.3 \cdot 10^{-3}$	$6.0 \cdot 10^{-3}$	$3.5 \cdot 10^{-10}$	$2.3 \cdot 10^{-9}$
4	—	—	—	—
5	$6.0 \cdot 10^{-3}$	$6.3 \cdot 10^{-3}$	$3.9 \cdot 10^{-9}$	$2.3 \cdot 10^{-9}$

CONCLUSIONS

The Ti-SS transition sample under consideration has shown excellent behaviour at the room, liquid nitrogen and liquid helium temperatures, as well as under high pressure tests and after thermal cycling. The helium leak rate of the sample was $(1 \cdot 10^{-10} \pm 10\%)$ mbar · l/s. Metallographic research proved that joint of stainless steel and titanium has high quality. This result is very good for initial tests of this type of welding, i.e., by using the explosion bonding technique. To obtain more reliable data and statistics, it is necessary to perform similar tests with a larger number of samples. These experiments are supposed to be continued to reach this goal. We are also planning to carry out installation of one (or more) tube on a 3.9 GHz helium vessel and test it in a Horizontal Test Cryostat at 2 K for an integrity test of only demonstration that tube can operate at 2 K after a cool-down and warm-up. A metallographic analysis of the explosion bonding welded joint will be also performed to get more information about the structure of the welded surface and the surrounding area.

REFERENCES

1. Chernikov A. N. et al. Shaft Cryostat on the Basis of Closed-Circuit Refrigerator for Neutron Powder Diffraction Studies in the Temperature Range 6–300 K. JINR Commun. P8-2005-23. Dubna, 2005 (In Russian).

Received on July 18, 2008.